

DRF4432D20I 20dBm ISM RF Transceiver Module

V1.40

Features

- FSK transceiver Module
- ISM frequency bands
- 38.4K bps data rate
- Multiple channels
- 20dBm Max. output power
- Baud rate configurable
- 4 bytes NetID & 2 bytes NodeID
- Interface: TTL/RS232/RS485
- Standby current < 5uA
- Supply voltage 3.4~5.5V

Application

- Home automation
- Security alarm
- Telemetry
- Contactless access
- Automatic meter reading
- Wireless data logger
- Remote motor control
- Wireless sensor network



DRF4432D20I-M1



DRF4432D20I-M2



DRF4432D20I-L1/L2

DESCRIPTION

DRF4432D20I is a low-cost sub-1 GHz transceiver module designed for operations in the unlicensed ISM (Industrial Scientific Medical) and LPRD bands. FSK (Frequency Shift Keying) modulation/demodulation, multi-channel operation, high bandwidth efficiency and anti-blocking performance make DRF4432D20I modules easy to realize the robust and reliable wireless link.

The module can be configured to work in 40 channels with 1MHz channel space, which reduces the interference from adjacent channels. It contains NetID and NodeID. Only modules with the same NetID can communicate. The NodeID of modules can be different and it doesn't affect the normal use. The ID is reserved for the future network module.

DRF4432D20I integrates 256 bytes buffer. When the buffer is empty, users can transfer 200 bytes data per time and even limitless data transfer can be achieved as long as RF data rate (RF module to RF module) is configured to be faster than UART data rate (MCU to RF module). The module

provides standard UART/TTL interface for selection. Users can choose seven data rates and three parity checks which make DRF4432D20 possibly tailor-made for different applications.

DRF4432D20 operates at 3.4~5.5V with extra low standby current which makes it suitable for battery powered-up applications.

PIN FUNCTIONS

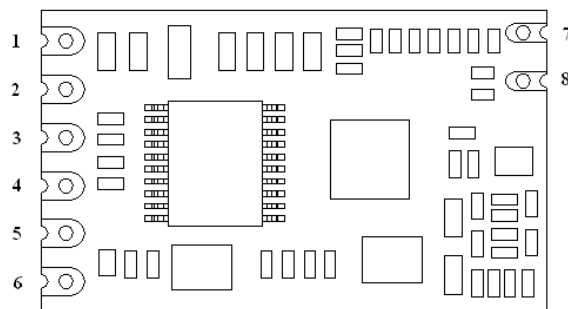

Figure 1: DRF4432D20I-M1/M2 Pin Layout

PIN	M1/M2	L1	L2	Function	Description
1	VCC	VCC	VCC	Power	Power supply
2	GND	GND	GND	Ground	Ground (0V)
3	TXD	RS232 TX	A	Output	UART TTL output / RS232 TX / RS485+
4	RXD	RS232 RX	B	Input	UART TTL input / RS232 RX / RS485-
5	SET	SET	SET	Input	Configuration pin. Low → configure mode
6	CS	CS	CS	Input	Enable pin. Low → sleep mode
7	GND			Ground	Antenna ground
8	ANT			---	Antenna port: 50 Ohm

Table 1: DRF4432D20I Pin Functions

ELECTRICAL SPECIFICATIONS

Symbol	Parameter (condition)	Min.	Typ.	Max.	Units
VCC	Supply Voltage	3.4		5.5	V
Temp	Operating temperature range	-20	25	70	°C
RH	Operating relative humidity	10		90	%
Freq	Frequency range	414.92 470.92 849.92 895.92	433.92 470.92 868.92 914.92	453.92 470.92 888.92 934.92	MHz

F _{DEV}	Modulation deviation			30		KHz
Mod	Modulation type			FSK		
I _{DD_R}	Current in receive mode	@ 433Mhz		25		mA
		@ 868Mhz		25		
		@ 915Mhz		25		
I _{DD_T} ⁽¹⁾	Current in transmit mode	@ 433Mhz		85		mA
		@ 868Mhz		85		
		@ 915Mhz		85		
I _{DD_S}	Current in sleep mode	@ 433Mhz		5		uA
		@ 868Mhz		5		
		@ 915Mhz		5		
P _{out}	Transmit Output power	@ 433Mhz		18.5	20	dBm
		@ 868Mhz		18.5	20	
		@ 915Mhz		18.5	20	
Sen. ⁽²⁾	Receive sensitivity	@ 433Mhz		-118		dBm
		@ 868Mhz		-118		
		@ 915Mhz		-118		
DR _{FSK}	FSK data rate		1.2		38.4	Kbps
DR _{IN}	Interface data rate		1.2		38.4	Kbps
CH _{BW}	Channel spacing			1		MHz
Z _{ANT}	Antenna Impedance			50		Ohm

Table 2: DRF4432D20I Electrical Specifications

Notes:

- (1) Transmit current is tested at the Max. output power.
- (2) Sensitivity is measured at 1.2k bps data rate.

ABSOLUTE MAXIMUM RATINGS

Symbol	Parameter	Min.	Max.	Units
VCC	Supply Voltage	-0.3	5.5	V
VI	Input voltage	-0.3	VCC+0.3	V
VO	Output voltage	-0.3	VCC+0.3	V
TST	Storage temperature	-55	125	°C

Table 3: DRF4432D20I Maximum Ratings

SETTING PARAMETERS

1. Default Settings

Parameter	Option	Default Value	Unit
MCU data rate	1.2, 2.4, 4.8, 9.6, 14.4, 19.2, 38.4	9.6	Kbps
Parity Check	No check, Even parity, Odd parity	No check	
Stop bit	1, 2 bits	1	bit
Data bit	7, 8, 9bits	8	bits
NetID	00000000~FFFFFFFF	00000000	
NodeID	0000~FFFF	0000	
Frequency	414.92 ~ 453.92MHz	433.92	MHz
	470.92~509.92MHz	470.92	
	849.92 ~ 888.92MHz	868.92	
	895.92 ~ 934.92MHz	914.92	
RF FSK data rate	1.2,2.4, 4.8, 9.6, 14.4,19.2, 38.4	9.6	Kbps
Output Power	0 ~ 7 levels	7 (20dBm)	

Table 4: DRF4432D20I Default Settings

The modules can work with the default settings. If users want to use different parameters and data format, users can use USB converter board or MCU to change the default settings.

2. Parameter Setting

BY MCU: Users can configure the parameters (frequency, data rate, output power, etc.) of DRF4432D20I module through MCU with the commands below or use the default parameters directly. The default series data rate to communicate with MCU is 9.6k bps baud rate, 8 data bits, 1 stop bit and no parity check.

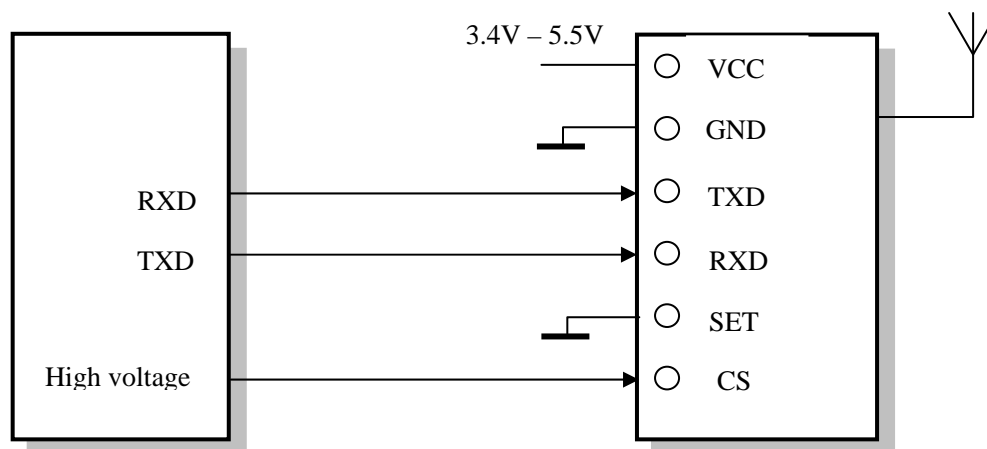

Figure 2: Connecting Diagram in MCU Configuration Mode

The command format is **AA FA + Command code + Parameters**.

■ **Command [AA]**

It is used to access product type and version number. No parameters are needed. Please note that the part name and version number might be a slightly different because of software update or hardware optimization.

Write: AA FA AA

Response: “ RF4432D20_VER1.0\r\n ”

■ **Command [01]**

Read command is used to read the present parameters stored in module. CH refers to channel number and Freq band is the frequency band.

Write: AA FA 01

Response: CH + Freq band + RF FSK data rate + Output power + Serial data rate + Data bits + Stop bit + Parity check + NetID + NodeID + \r\n

■ **Command [02]**

This command is used to restore the default parameters set in factory.

Write: AA FA 02

Response: OK\r\n Or ERROR\r\n

■ **Command [03]**

Write command is used to configure the parameters of module according to applications. The parameters are totally 14 bytes.

Write: AA FA 03 XX XX XX XX XX XX XX XX XX XX XX XX XX XX XX

Response: OK\r\n or ERROR\r\n

1) Channel number [Byte 01]

CH	433FB	470FB	868FB	915FB	CH	433FB	470FB	868FB	915FB
1	414.92	470.92	849.92	895.92	21	434.92	490.92	869.92	915.92
2	415.92	471.92	850.92	896.92	22	435.92	491.92	870.92	916.92
3	416.92	472.92	851.92	897.92	23	436.92	492.92	871.92	917.92
4	417.92	473.92	852.92	898.92	24	437.92	493.92	872.92	918.92
5	418.92	474.92	853.92	899.92	25	438.92	494.92	873.92	919.92
6	419.92	475.92	854.92	900.92	26	439.92	495.92	874.92	920.92
7	420.92	476.92	855.92	901.92	27	440.92	496.92	875.92	921.92
8	421.92	477.92	856.92	902.92	28	441.92	497.92	876.92	922.92
9	422.92	478.92	857.92	903.92	29	442.92	498.92	877.92	923.92
10	423.92	479.92	858.92	904.92	30	443.92	499.92	878.92	924.92
11	424.92	480.92	859.92	905.92	31	444.92	500.92	879.92	925.92
12	425.92	481.92	860.92	906.92	32	445.92	501.92	880.92	926.92

13	426.92	482.92	861.92	907.92	33	446.92	502.92	881.92	927.92
14	427.92	483.92	862.92	908.92	34	447.92	503.92	882.92	928.92
15	428.92	484.92	863.92	909.92	35	448.92	504.92	883.92	929.92
16	429.92	485.92	864.92	910.92	36	449.92	505.92	884.92	930.92
17	430.92	486.92	865.92	911.92	37	450.92	506.92	885.92	931.92
18	431.92	487.92	866.92	912.92	38	451.92	507.92	886.92	932.92
19	432.92	488.92	867.92	913.92	39	452.92	508.92	887.92	933.92
20	433.92	489.92	868.92	914.92	40	453.92	509.92	888.92	934.92

Table 5: DRF4432D20I Channel Number Parameter

2) Frequency band [Byte 02]

Parameter	01	02	03	04
Freq Band	433MHz	470MHz	868MHz	915MHz

Table 6: DRF4432D20I Frequency Band Parameter

3) RF FSK data rate in bps [Byte 03]

Parameter	0	1	2	3	4	5	6
Data rate	1200	2400	4800	9600	14400	19200	38400

Table 7: DRF4432D20I FSK Data Rate Parameter

4) RF output power in dBm [Byte 04]

Parameter	0	1	2	3	4	5	6	7
Power	-1	+2	+5	+8	+11	+14	+17	+20

Table 8: DRF4432D20I Output Power Parameter

5) Serial data rate in bps [Byte 05]

Parameter	0	1	2	3	4	5	6
Data rate	1200	2400	4800	9600	14400	19200	38400

Table 9: DRF4432D20I Serial Data Rate Parameter

6) Serial data bit [Byte 06]

Parameter	1	2	3
Data bit	7	8	9

Table 10: DRF4432D20I Serial Data Bit Parameter

7) Stop bit [Byte 07]

Parameter	1	2
Stop bit	1	2

Table 11: DRF4432D20I Stop Bit Parameter

8) Parity check [Byte 08]

Parameter	1	2	3
Parity check	No	Odd	Even

Table 12: DRF4432D20I Parity Check Parameter

9) Net ID [Byte 09 ~ 12] : 00000000 ~ FFFFFFFF

10) Node ID [Byte 13 ~14]: 0000 ~ FFFF

■ **Command [04]**

When the module is in configuration mode, it will detect the RSSI value. Users can send this command to detect the RSSI [0x00~0xFF] in present channel.

Write: AA FA 04

Response: RSSI + 00 + \r\n

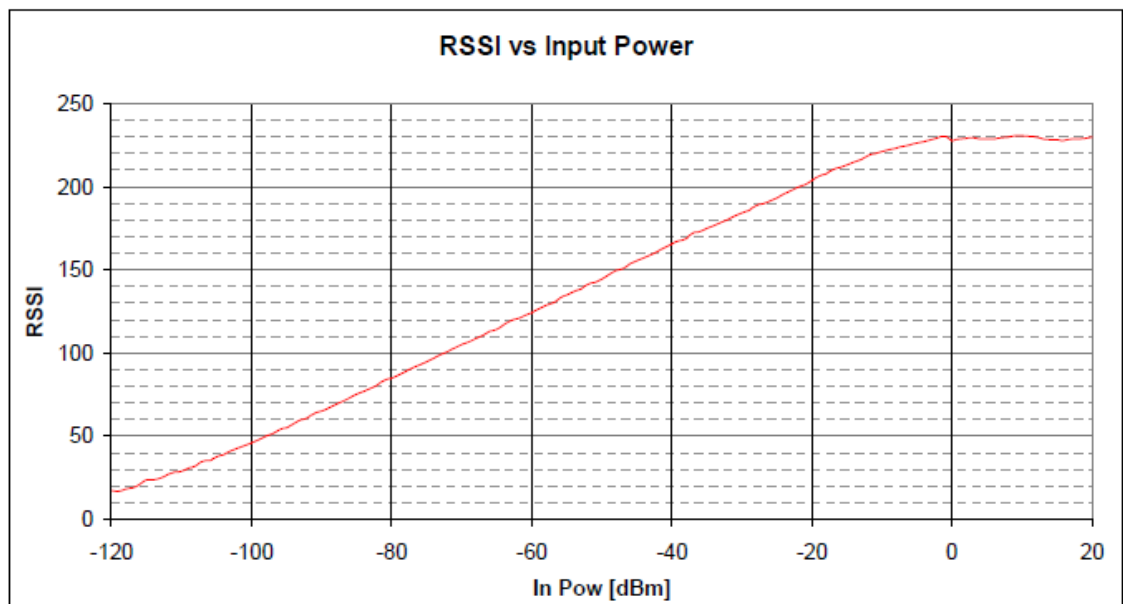

Figure 2: RSSI vs dBm

BY Computer: Users also can use USB converter board to configure the parameters by computer. USB-to-TTL converter board DAC03 is for TTL interface module DRF4432D20I-M1/2. USB-to-RS232 converter board DAC13 for RS232 module DRF4432D20I-L1 and USB-to-RS485 converter board DAC23 is for RS485 interface module DRF4432D20I-L2. After installing USB driver successfully, users can insert the modules into USB converter board with corresponding pin sequence directly and then run configuration tool to set the parameters of module.

- USB driver.: http://www.dorji.com/pro/tool/DACx3_USB_Driver.rar
- Configuration tool.: http://www.dorji.com/pro/tool/DRF_Tool_DRF4432D20I.rar
- Operation manual: <http://www.dorji.com/docs/app/DACx3.pdf>

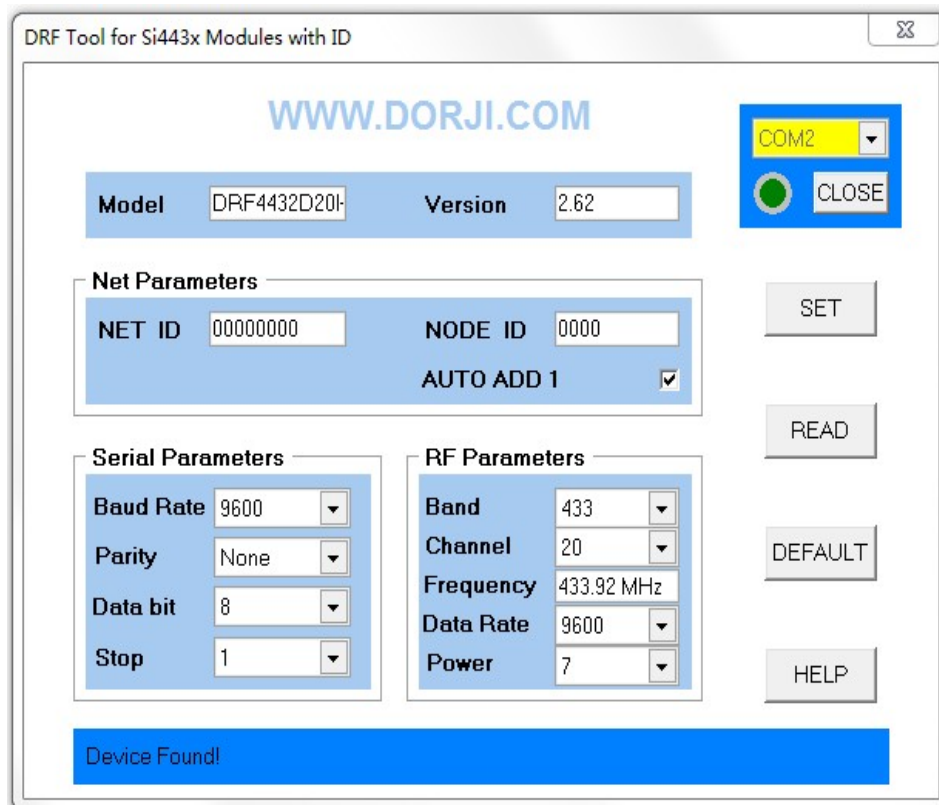

Figure 4: Configuration Tool

At present the configuration tool only recognizes COM port not larger than COM8. After installing the USB driver successfully and inserting the USB board into computer, users can check which COM port is occupied by the board by opening Device Manager of Windows operation system.

MECHANICAL DATA

Unit:mm

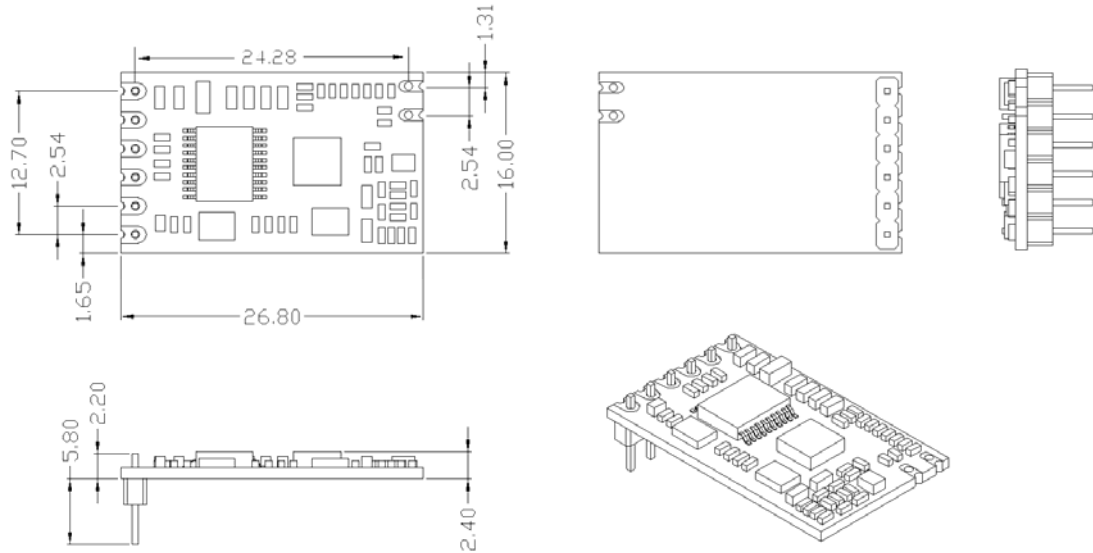

Figure 5: DRF4432D20I-M1 Dimension

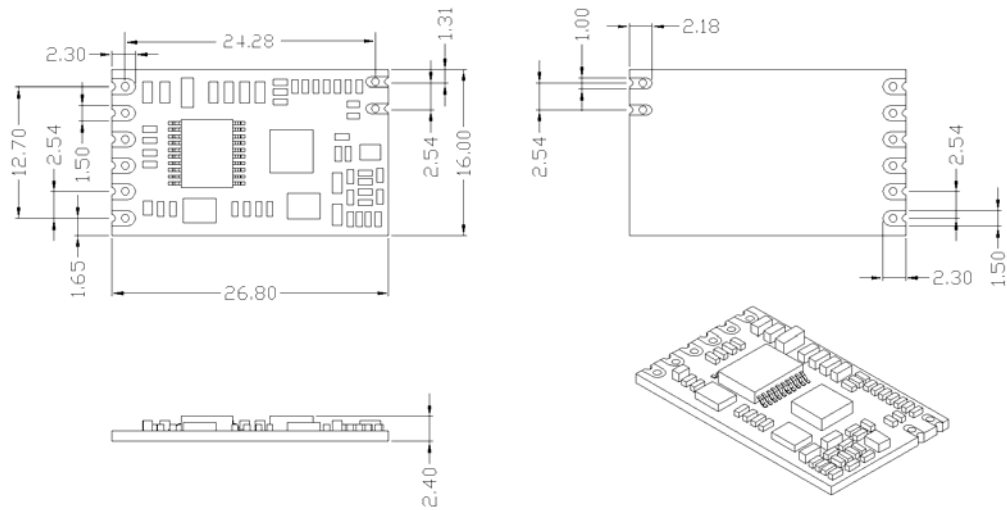

Figure 6: DRF4432D20I-M2 Dimension

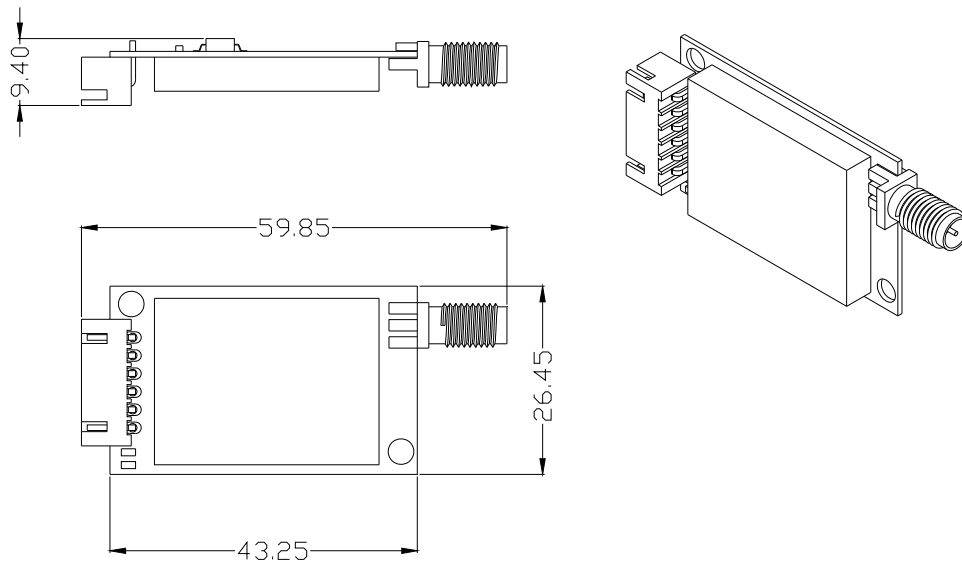

Figure 7: DRF4432D20I-L1/2 Dimension

ORDERING INFORMATION

DRF 4432 D 20 I — 043 M1

① ② ③ ④⑤ ⑥ ⑦

Num	Symbol	Meaning
①	RF module	RF GFSK module
②	IC Type	SI4432
③	Module Function	Data transmission
④	Power	20dBm output power
⑤	ID	Module with ID function
⑥	Freq. Band	043: 433MHz 047: 470MHz 086:869Mhz 091:915Mhz
⑦	Package	M1: Mini TLL DIP package M2: Mini TTLSMD package L1: RS232 interface with SMA L2: RS484 interface with SMA

Table 13: Ordering Information

<p>Dorji Applied Technologies A division of <i>Dorji Industrial Group Co., Ltd</i></p> <p>Add.: Xinchenuayuan 2, Dalangnanlu, Longhua, Baoan district, Shenzhen, China 518109</p> <p>Tel: 0086-755-28156122 Fax.: 0086-755-28156133 Email: sales@dorji.com Web: http://www.dorji.com</p>	<p>Dorji Industrial Group Co., Ltd reserves the right to make corrections, modifications, improvements and other changes to its products and services at any time and to discontinue any product or service without notice. Customers are expected to visit websites for getting newest product information before placing orders.</p> <p>These products are not designed for use in life support appliances, devices or other products where malfunction of these products might result in personal injury. Customers using these products in such applications do so at their own risk and agree to fully indemnify Dorji Industrial Group for any damages resulting from improper use.</p>
--	---